



TECHNICAL DATASHEET

TAB POLAR S95J

ORDER INFORMATION

TAB ID
246895

Short Code
S95J

DIN Marking
59518 SMF

EAN Code
3838807030398

Quantity per EU/CNT pallet
42/70 pcs

TECHNOLOGY

Primary Function
Engine Start

Battery Technology
Flooded

Grid Type (pos/neg)
Expanded/Concasted

Grid Alloy (pos/neg)
Ca/Ca

Separator
PE

Electrolyte (g/cm³)
1,28

TECHNICAL INFORMATION

Voltage (V)
12

Capacity C20 (Ah)
95

CCA -18°C EN (A)
850

RC (min)
171

LxWxH (mm)
306x173x220/221

Total Weight (kg)
20.9

BOX DESIGN

Box Type
D31

Cover Type
SMF

Colour
Black

Layout
0

BHD
B01

Terminal
1

DRAWING

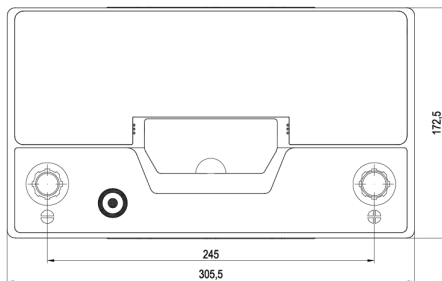
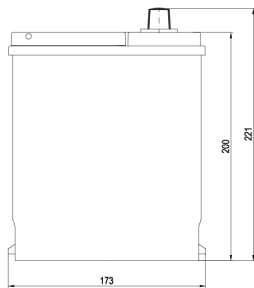
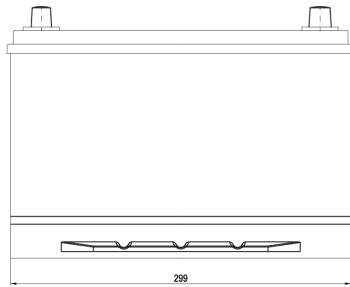

BHD

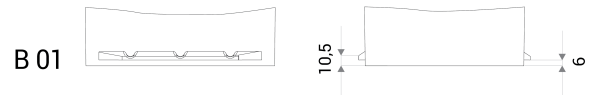

LAYOUT

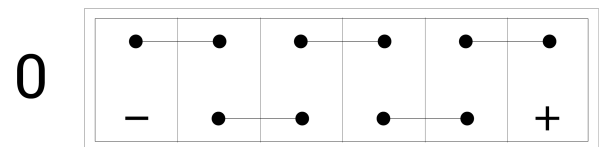

TERMINAL

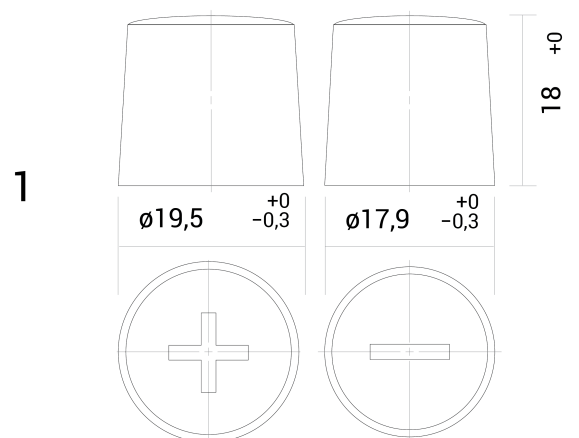

TECHNICAL DATASHEET

TAB POLAR S95J